

# RoVent<sup>®</sup>

Automatic Ventilator  
Volume & Pressure Controlled

## User's Guide

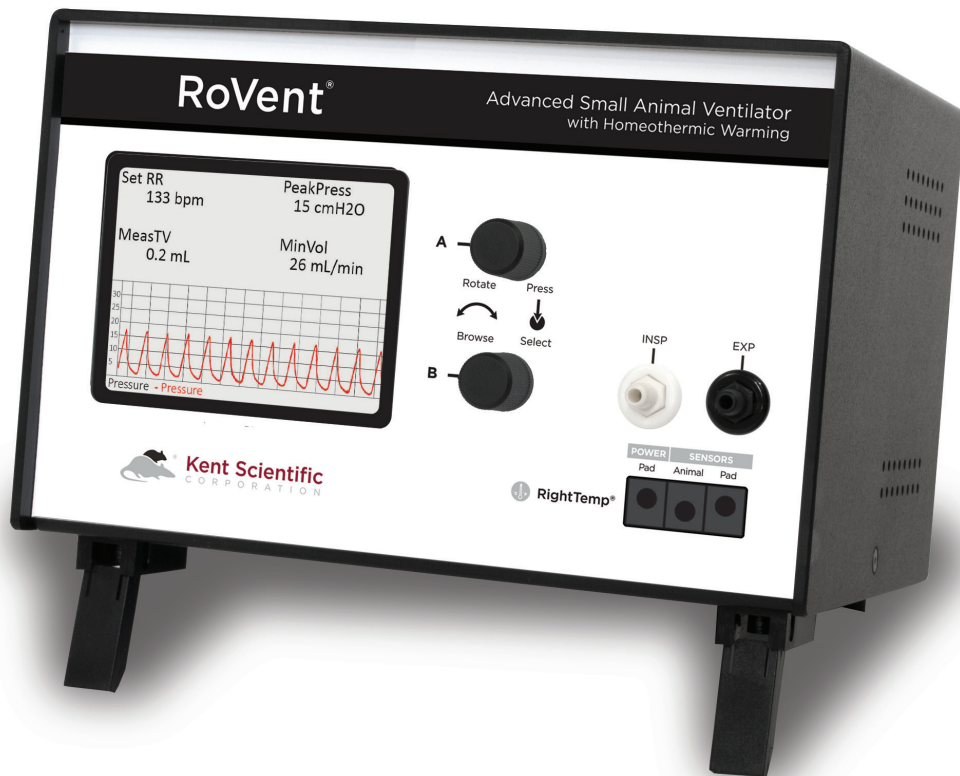

# RoVent<sup>®</sup>

Automatic Ventilator  
Volume & Pressure Controlled

## User's Guide

# TABLE OF CONTENTS

<b>Introduction</b> .....	1
System Components .....	1
Navigating RoVent® .....	2
Touchscreen .....	2
Control .....	2
Display Options .....	3
Menus .....	4
Alarms .....	4
<b>RoVent®</b>	
<b>Automatic Ventilator</b> .....	5
Set Up Hardware .....	5
Air Source .....	5
RoVent® Run Screen.....	7
Initial Set-Up .....	7
Configure Settings.....	8
Procedure for Use .....	10
Troubleshooting .....	12
<b>RightTemp®</b>	
<b>Temperature Monitor and Homeothermic Warming</b> .....	11
Set Up Hardware .....	11
Configure Settings.....	12
Monitoring an Animal.....	12
Troubleshooting .....	13
Right Temp Pad & Sensor Maintenance.....	16
<b>General Information</b> .....	14
Contact .....	14
Warranty and Satisfaction Guarantee .....	14
Specifications .....	15
<b>Index</b> .....	17

# Introduction

The RoVent® is not designed, intended or authorized for use in human applications.

## System Components

### Front Panel

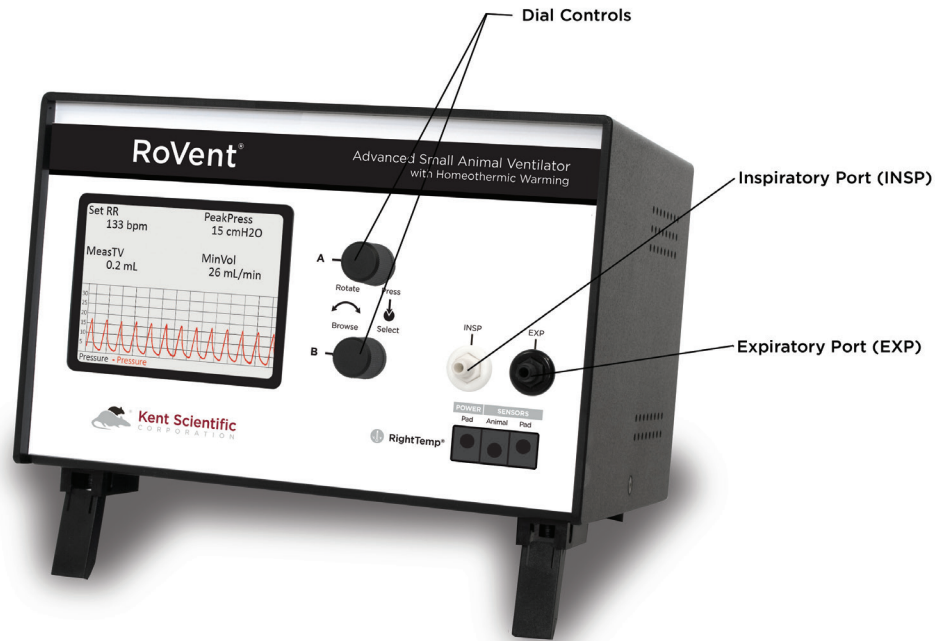

### Back Panel



### Side Panel

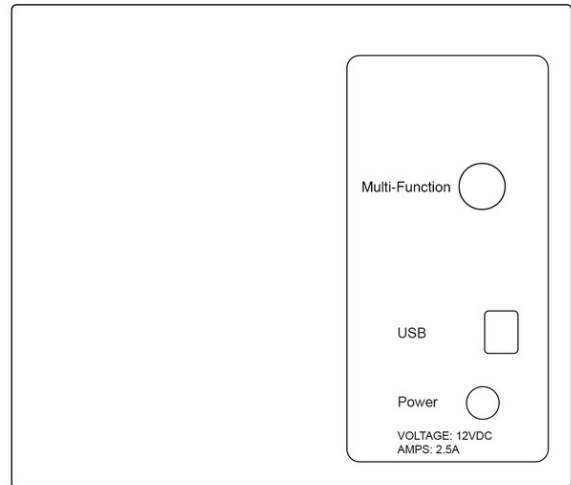

# Navigating RoVent®

## Touch Screen

RoVent® Touch Screens offer quick access to most features and settings. Touch the upper half of the Run Screen to reach the first Touch Screen.

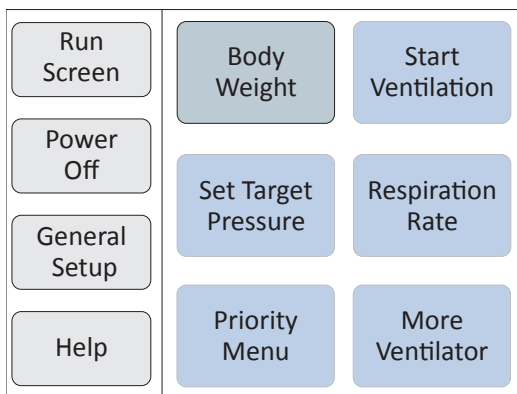

First Touch Screen  
(Screen buttons may vary based on the modules installed.)

Touch the bottom half of the Run Screen to open the pop-up Display Menu and quickly scroll through charts, view other data or to silence Alarms.

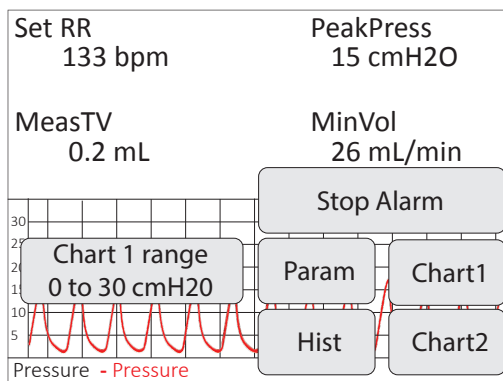

Pop-Up Display Menu  
(Screen buttons may vary based on the modules installed.)

## Dial Control

There are two Dials, A and B. The function of a Dial varies based on:

- where you use it - from the Touch Buttons Screens, Run Screen, Menu Screens or Main Menu.
- how you use it - turn, press or hold down.

Dials can have specialized uses in a few specific locations. The unit displays on-screen instructions in those locations.

ACTION	DIAL	RESULT
Press	A	Back one level from Main Menu Screens To Run Screen from Main Menu To Run Screen from Touch Button Screens
	B	Select a highlighted Menu item To Main Menu from Home Screen Clear Alarms if they are enabled
Turn	A	Move through Menu choices
	B	Change setting values at Menus
Hold down	A	To Main Menu from Run Screen To Help at any Menu screen
	B	–

**See Main Menu  
on page 4.**

## Display Options

### Customizing the Run Screen Display:

#### To configure Parameters:

1. Touch:
  - 1) the upper half of the Run Screen for the Touch Screen Menu.
  - 2) "General setup".
  - 3) "Config".
  - 4) "Param Locations".
  
2. Turn Dial A to choose a Parameter and Dial B to assign the Parameter to a Run Screen location.

#### To configure Charts:

1. Touch:
  - 1) the upper half of the Run Screen for the Touch Screen Menu.
  - 2) "General setup".
  - 3) "Config".
  - 4) "Chart 1 setup" or "Chart 2 setup" to choose the type and timing for a chart.
  
2. Press Dial A to return to the General setup page of the Touch Screen Menu.
  
3. Touch "Set ranges" to choose the best-fitting axis range for the Parameters on your charts.

## Menus

The Main Menu is the non-touch gateway to all features and setting choices for configuring RoVent®, useful when a touch screen is not a feasible option, such as for an operator with damp hands. Access the Main Menu through the Touch Screen Menu or from the Run Screen by holding Dial A.

Main Menu	
Body wgt	Set body weight
Vent	
Modules	30g
Config	Nominal RR: 133bpm
Power off	Nominal Tidal Vol: 0.200mL
Help	Nominal Minute Vol: 26mL/min
	Turn Dial B to choose the weight of your animal
	Hold Dial A for Help.

### Main Menu

(Screen buttons may vary based on the modules installed.)

## Alarms

RoVent® system alarms alert you to certain conditions that might require attention while RoVent® is running.

There are two levels of alarms:

Level	Based On	Banner	Sound (If On)	Configurable
Warning	Parameters or other operating conditions	Yellow	1-beep pattern	Yes
Serious	Parameters or other operating conditions	Red	3-beep pattern	Yes except for system alarms

### ***To clear a sounding alarm:***

A triggered alarm produces a colored banner at the bottom of the screen describing the cause of the alarm. The banner color corresponds to the severity of the alarm.

To silence the alarm:

Touch:

- 1) the bottom half of the Run Screen.
- 2) "Stop Alarm".



# RoVent<sup>®</sup> Automatic Ventilator



## Set Up Hardware

### Air Source:

#### If you are using a Compressed Gas Source or an Anesthetic Vaporizer:

1. Remove the caps from rear ports and allow them to remain open to atmosphere.
2. Connect the Ventilator Tubing Adaptors to the ports, and attach the Intubation tubing.

The hub of a standard catheter endotracheal tube will slide over the end of the white fitting.

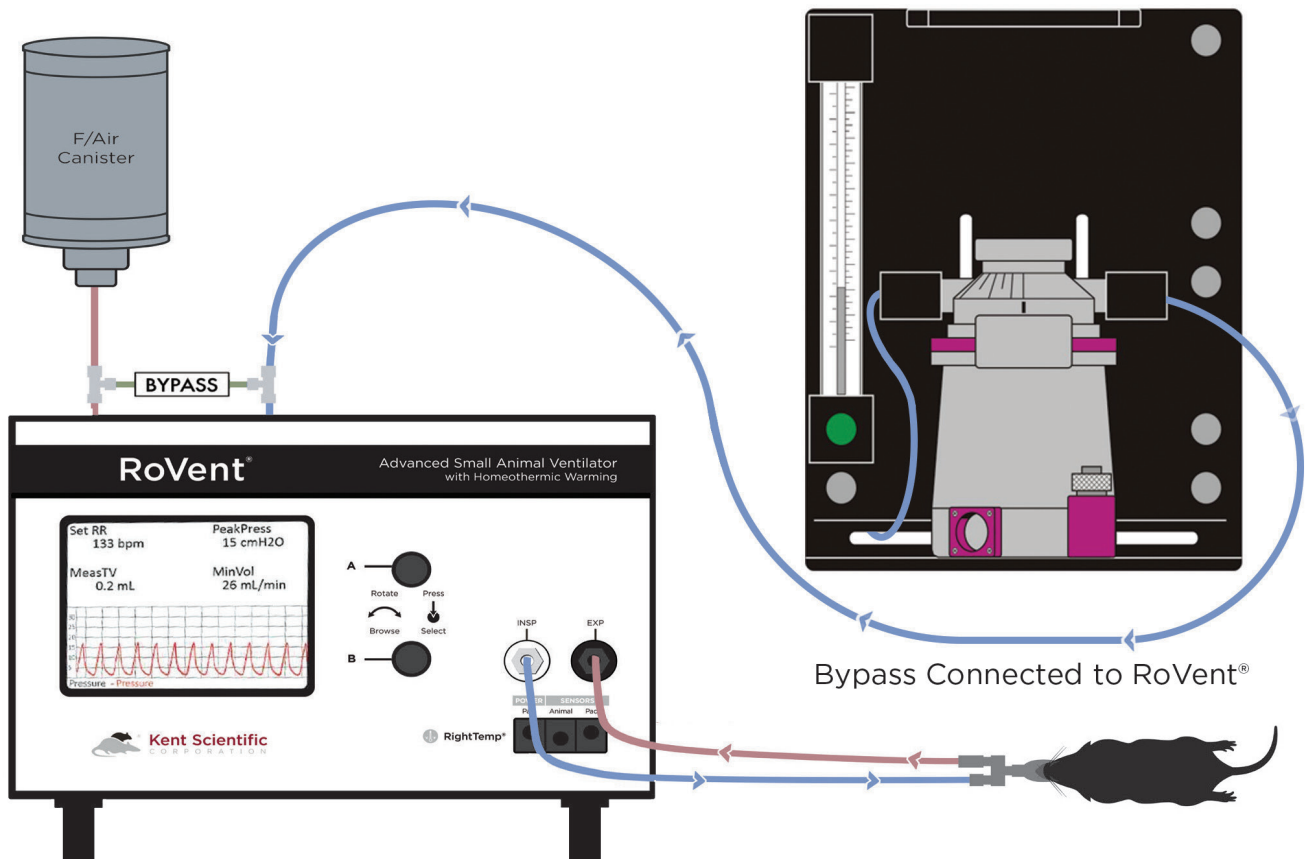





## If ventilating using an anesthetic gas vaporizer or compressed gas source:

1. Connect the Bypass Assembly to the rear ports of the RoVent.

**Note:** The RoVent is designed to operate with the ports at neutral pressure. The Bypass Assembly is required to neutralize any pressure buildup in the rear tubing. Backpressure can affect ventilator function.

2. Connect the anesthetic vaporizer or compressed gas source to the Inlet side of the Bypass, and a passive scavenging system (such as a charcoal canister) to the exhaust port.

**Note:** Kent Scientific does not recommend connecting active scavengers directly to the exhaust tubing.

3. Connect the Ventilator Tubing Adaptors to the ports, and attach the Intubation Tubing.

The hub of a standard catheter endotracheal tube will slide over the end of the white fitting.

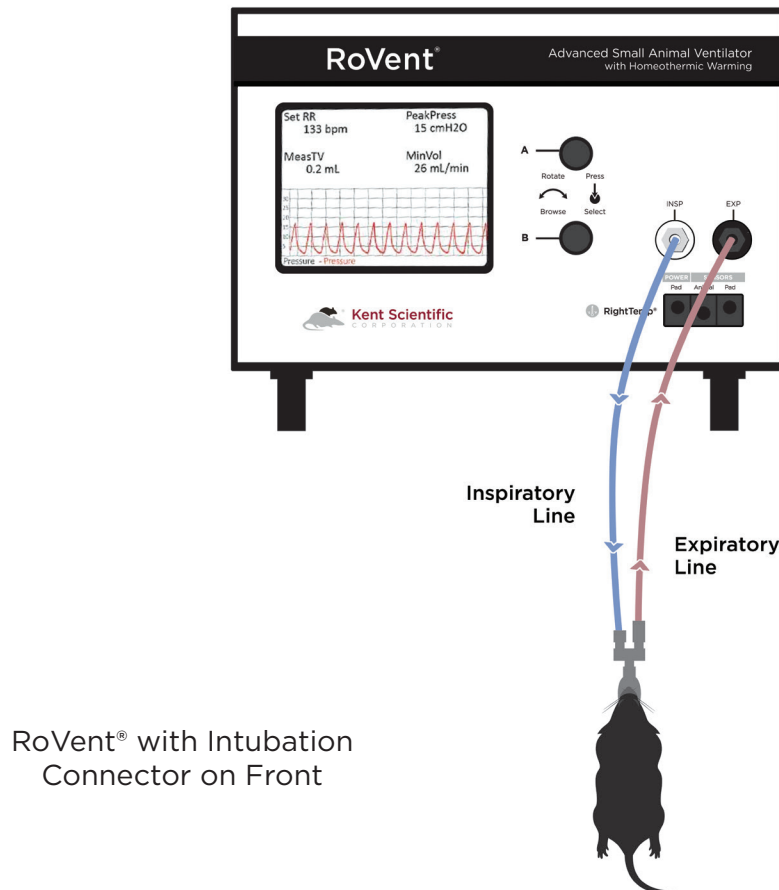



## Initial Set-Up

---

### *Ventilator Calibrations:*

The first time the Ro Vent is used, or any time the accessories have changed, be sure to perform a Deadspace Calibration and verify the ventilator settings.

**Note:** Never perform these functions when an animal is connected to the ventilator.

#### 1. Measure Deadspace

The Deadspace calibration will measure the volume of tubing between the RoVent® and the animal. It is important that the Deadspace is recalibrated every time the tubing configuration is changed to maintain accurate tidal volume delivery.

- 1) Set up tubing.
- 2) From the Vent Run Screen, touch Setup then More Ventilator.
- 3) Touch Calib & Tests, then Measure Deadspace.
- 4) Firmly seal the end of the endotracheal tube connector with your finger or a cap, ensuring that there is no air leakage.
- 5) Press Dial B. When asked to confirm measurement, press Dial B again.

The first time the RoVent® is used, or any time the accessories have changed, be sure to perform a Deadspace Calibration and verify the ventilator settings.

**Note:** Never perform these functions when an animal is connected to the ventilator.

#### 2. Zero Sensors

Zeroing the sensors ensures that the internal pressure and flow sensors are working properly, and calibrates them prior to the ventilation. It is important that the sensors are zeroed to ensure accurate inspiratory pressure delivery.

- 1) Set up tubing.
- 2) From the Vent Run Screen, touch Setup then More Ventilator.
- 3) Touch Calib & Tests, then Zero Sensors.
- 4) Press Dial B. When asked to confirm measurement, press Dial B again.



## Configure Settings

Configure all ventilator settings from the Vent Run Screen.

**Pressure Priority:** RoVent® ventilates to a specified inspiratory pressure. The default target pressure is 15cmH<sub>2</sub>O independent of body weight setting. To change the target pressure, touch **Set Target Pressure**.

**Volume Priority:** RoVent® delivers an initial target pressure for the first breath, then delivers a target tidal volume. The default target tidal volume is calculated based on body weight. To change the target tidal volume, touch **Set Target Volume**.

**Note:** You can change the initial target pressure for the first breath, as well as the minimum and maximum allowed pressures to customize the ventilator's operating range as the ventilator delivers the set tidal volume.

The Vent Setup also allows you to make advanced ventilation settings:

- **PEEP:** Automatically add a positive end-expiratory pressure.
  - Choose between 0cmH<sub>2</sub>O and 9cmH<sub>2</sub>O.
  - Used to prevent alveolar collapse during open-chest procedures.
- **Sigh Breath:** Automatically add an intermittent breath with a larger tidal volume.
  - Choose frequency and tidal volume of sigh breaths.
  - Evenly distributes inspiratory pressure to prevent partial alveolar collapse.
- **I/E Ratio:** Change the breath mechanics.
  - Choose the ratio of inspiratory to expiratory portions of a breath cycle.
  - Useful to increase oxygenation in certain respiratory models.
- **Inspiratory Pause:** Change the breath mechanics.
  - Choose the time between the end of active inspiration and the start of expiration.
  - Useful to increase oxygenation in certain respiratory models.



- **Assist Mode:** Change the breath pattern.
  - Choose how an animal is allowed to breathe at a spontaneous respiration rate, while the ventilator retains control of target inspiratory pressure or target tidal volume.
  - Useful during recovery from long procedures, or in certain respiratory models.

**Tip: Assist Mode settings override Respiration Rate settings as long as Assist Mode is enabled.**

- **Pulse Mode:** Change the breath pattern.
  - Choose how the ventilator structures the breath cycle.
  - Useful to apply rapid high pressure to animal's airways to evenly distribute inspiratory pressure and prevent partial alveolar collapse.

**Tip: Pulse Mode Menu settings override target pressure and target volume settings as long as Pulse Mode is enabled.**



## Procedure for Use

**Caution:** If you choose to alter the tubing length, be sure to recalibrate the deadspace. See page 7.

1. Touch Vent to open the RoVent® Run Screen.
2. Touch Start Vent to begin ventilation.

**Caution:** Do not start the ventilator before the animal is intubated and connected to the ventilator tubing.

3. Enter the animal weight.

**Tip:** The RoVent calculates the respiration rate and tidal volume using the animal's body weight.

To change these settings, turn Dial A or Dial B. Touch Setup from the Vent Run Screen to make other changes to Respiratory Rate, Target Pressure, Tidal Volume, or other advanced settings

4. From the Vent Run Screen, touch Stop Vent to stop air flow.

### *Trigger Command Settings:*

You can assign RoVent-specific functions to either a Dial press or an external signal via remote cable.

To set a new Trigger Command:

1. From the Vent Run Screen, touch Setup, then More Ventilator.
2. Touch Triggers Menu.
3. Turn Dial B to choose an action.

Some actions will require additional settings. Please contact Kent Scientific if you need assistance in enabling a trigger function.



---

### ***Constant Flow Mode:***

For setups where a constant flow or gas passthrough is required, the Ro Vent can be set to Air Mode. To access Air Mode, touch the Air menu.

Air Mode contains three different flow options:

1. Body Weight Flow: Preset based on the Body Weight setting
2. Low Flow: User settable
3. High Flow: User settable

The flow can be adjusted and controlled as needed.

**Note:** Air Mode is not a mechanical ventilation feature and will not control the animal's respiration.

### ***Raw Override Mode:***

For setups where the RoVent's safety parameters are not desired, the RoVent can be set to Raw Override Mode. Raw Mode will ignore the RoVent's 30cmH<sub>2</sub>O Inspiratory Pressure limit, allowing the user to customize the breath shape. To access Raw Mode, touch Setup from the Vent Run Screen.

**Note:** Raw Mode is a full ventilator override, and injury to the animal may occur.



# RoVent® Troubleshooting

## Alarm Messages

Message	Definition	Solution
<b>Tube open to atmosphere</b>	The highest measured pressure in a breath cycle is under 25% of the target and the tidal volume is over target.	<ul style="list-style-type: none"><li>• Check the tubing between the INS and EXP ports for leaks or loose connections.</li><li>• The ventilator circuit is open. Do not run the ventilator prior to connecting the animal.</li><li>• Verify that the Body Weight or Target tidal volume setting is correct and that the delivered tidal volume is an appropriate value for the animal's size.</li><li>• If the error persists, perform a Leak Test in the Calib &amp; Tests section.</li></ul>
<b>Tube blocked</b>	The highest measured pressure in a breath cycle is under 25% of the target and tidal volume is under target.	<ul style="list-style-type: none"><li>• The endotracheal tube is not seated correctly.</li><li>• There is a kink, blockage or foreign matter in the inspiratory or expiratory lines.</li></ul>
<b>Exhaust blocked</b>	The breath pressure fails to drop during the expiratory phase of a breath.	<ul style="list-style-type: none"><li>• The cap is on the EXP port.</li><li>• The expiratory valve has failed.</li></ul>
<b>Out of regulation</b>	Over five consecutive breaths, peak pressure was more than 25% or less than 75% of your target.	<ul style="list-style-type: none"><li>• Requested Tidal Volume is too high for Pressure and RR .</li></ul>
<b>Large rise in TV</b>	Over the last four breaths, there was an increase of more than 25% in average tidal volume compared to that of the previous 16 breaths.	<ul style="list-style-type: none"><li>• Part of the tubing between the INS and EXP ports is open, disconnected or leaking.</li></ul>
<b>Large drop in TV</b>	Over the last four breaths, there was a decrease of more than 25% in average tidal volume compared to that of the previous 16 breaths.	<ul style="list-style-type: none"><li>• There is a kink in the tubing.</li><li>• There is foreign matter in the tubing or in the exhaust valve.</li><li>• The exhaust outlet is blocked.</li><li>• The endotracheal tube is not seated correctly.</li></ul>
<b>Deadspace calib</b>	Dead space calibration produced a negative tidal volume.	<ul style="list-style-type: none"><li>• Deadspace calibration is incorrect for current tubing setup.</li></ul>



## Diagnostic Procedures

To access these diagnostic procedures, open the Vent Run Screen, touch Setup, then More Ventilator, and Calib&Tests.

### Purge

Clears any accumulations from the valves using high pressure air flow.

Resulting Message	Meaning	Possible Action
<b>Success</b>	No leaks found.	None is needed.
<b>Low baffle pressure</b>	There is an internal RoVent problem.	Contact Kent Scientific.

### Leak Test

Checks for internal leaks as well as leaks in tubing circuits.

Resulting Message	Meaning	Possible Action
<b>Test OK</b>	No leaks found.	None is needed.
<b>Tubing leaks</b>	The tubing is open to the atmosphere through a loose connection or a crack or hole in the tubing.	Tighten all connections and ensure that the circuit is air tight. Run Leak test again. If the error recurs, contact Kent Scientific.
<b>Low baffle pressure or Baffle leaks</b>	There is an internal RoVent problem.	Retest making sure that the tubing is not flexed or moved. If the error recurs, contact Kent Scientific.





# RightTemp Temperature Monitor and Homeothermic Warming



## Set Up Hardware

1. Connect the warming pad to the “Pad Power” port on the front of the RoVent®
2. Choose one of the two probes as the body temperature sensor.
  - For mice, select the smaller probe.
  - For rats, select the larger probe.
3. Connect the body temperature sensor to the “Animal Sensor” port.
4. Use the other probe as the pad sensor.
5. Connect the sensor to the “Pad Sensor” port.

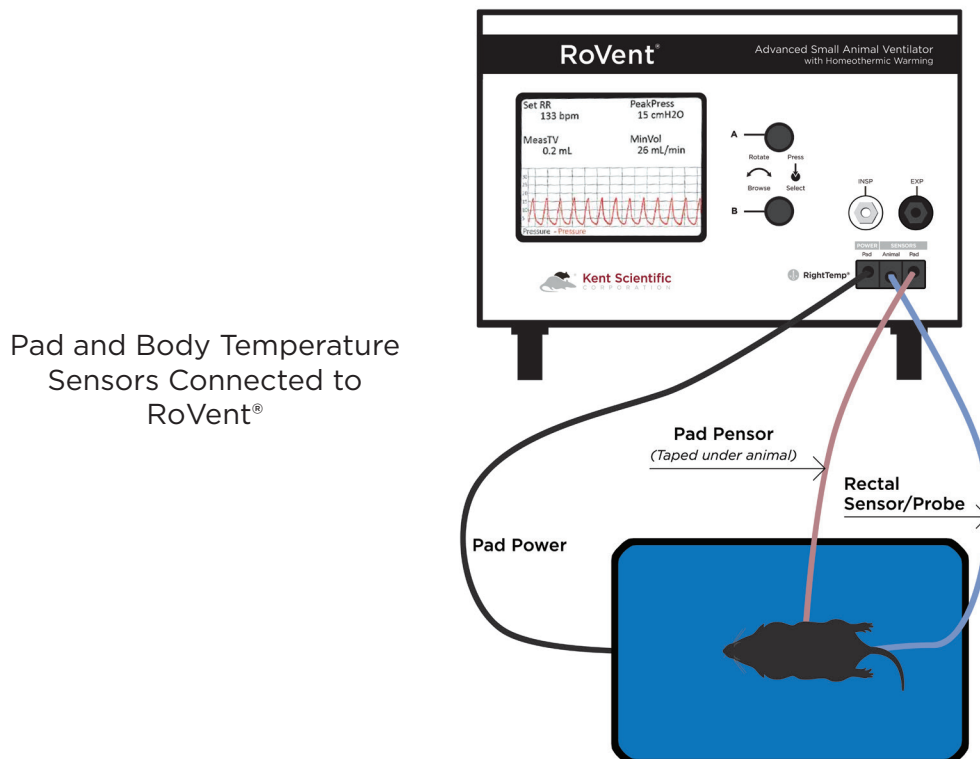

**We recommend that you secure the pad probe to the warming pad using tape, etc.**

## Configure Settings

---

### *RightTemp Sensor Calibration*

1. Place both sensors in a beaker of water and measure the water temperature with an accurate digital thermometer.
2. Wait for the screen display for the sensors to stabilize.
3. Touch:
  - 1) “General setup”.
  - 2) “RightTemp setup”.
  - 3) “Calibrate temp”.
4. Turn Dial B to enter the temperature as measured by the digital thermometer.
5. Press Dial B to save the calibration.

### *RightTemp Settings*

1. Touch:
  - 1) “General setup”.
  - 2) “RightTemp setup”.
  - 3) “Control warming” to choose the type of warming:
    - “Off”: temperature monitoring, no warming
    - “Unregulated”: temperature monitoring, warming with no sensor control
    - “Pad temp regulated”: temperature monitoring with Pad sensor control
    - “Body temp regulated”: temperature monitoring with Animal sensor control
2. Set the target temperature, limit the maximum pad temperature, or set the power level depending on the type of warming you have selected. Appropriate buttons will appear on the screen to allow you to make settings.

## Monitoring an Animal

---

1. Place the anesthetized animal on the warming pad.
2. Insert the animal temperature probe into the rectum of the animal. Secure the probe if necessary.

**Always secure the pad temperature probe beneath the animal.**



## RightTemp Troubleshooting

Problem	Possible Cause	Solutions
Pad is not heating.	Incorrect settings	<ul style="list-style-type: none"><li>• Ensure that all settings are properly enabled for warming and target temperatures are selected.</li></ul>
	Incorrect or loose connections	<ul style="list-style-type: none"><li>• Ensure that the connection at the back of the RoVent Jr is tight.</li></ul>
Pad is overheating.	Incorrect settings	<ul style="list-style-type: none"><li>• Ensure that all settings are properly enabled for warming and target temperatures are correctly selected.</li><li>• Enable a “Maximum Pad Temp” when type of warming is “Body temp regulated” to prevent overheating.</li></ul>
	Incorrect sensor placement	<ul style="list-style-type: none"><li>• Place pad sensors directly beneath the animal.</li><li>• Place animal sensor rectally only.</li></ul>
Sensors are reading incorrect temperatures.	Sensors calibration required	<ul style="list-style-type: none"><li>• Recalibrate the temperature sensors.</li></ul>
	Sensor function reassignment	<ul style="list-style-type: none"><li>• Recalibrate the temperature sensors. Do this any time you reassign sensor function.</li></ul>

## RightTemp Pad and Sensor Maintenance

- Use the disposable warming pad covers to prevent soiling the warming pad.
- Wipe the warming pad clean with a damp cloth if needed. Never saturate the warming pad.
- Gently wipe the sensors clean between uses.

# General Information

Thank you for purchasing a RoVent®. We truly appreciate your business. We strongly advise that you read and study this Owner's Manual to appreciate fully all the features, benefits, and capabilities of the RoVent®.

## Contact Information

---

Kent Scientific Corporation  
1116 Litchfield Street  
Torrington, Connecticut 06790  
E-mail: [sales@kentscientific.com](mailto:sales@kentscientific.com)

Toll-Free: 888-5RATTUS (888-572-8887)  
Outside US: 860-626-1172  
Fax: 860-626-1179  
Internet: [www.kentscientific.com](http://www.kentscientific.com)

## Disclaimer

---

Kent Scientific Corporation makes no representations or warranties, expressed, statutory or implied, regarding the fitness or merchantability of the components of this system for any particular purpose. Further, Kent Scientific Corporation is not liable for any damages, including but not limited to, lost profits, lost savings, or other incidental or consequential damages arising from ownership or use of these products, or for any delay in the performance of its obligations under the warranty due to causes beyond its control. In no case shall Kent Scientific Corporation's financial obligation extend beyond the cost of or replacement of the Kent product in question. Kent Scientific Corporation also reserves the right to make any improvements or modifications to these products described in this manual at any time, without notice of these changes. All brand and product names used in this manual are the trademarks of their respective owners.

**This product is not designed, intended or authorized for use in human applications.**

## Product Warranty

---

The RoVent® has a one (1) year warranty including all parts and labor charges. This warranty does not cover damage by any cause including, but not limited to, any malfunction, defect or failure caused by or resulting from unauthorized service or parts, improper maintenance, operation contrary to furnished instructions, shipping or transit accidents, modifications or repair by the user, harsh environments, misuse, neglect, abuse, accident, incorrect line voltage, fire, flood, other natural disasters, or normal wear and tear. Changes or modifications not approved by Kent Scientific Corporation could void the warranty. The foregoing is in lieu of all other expressed warranties. Kent Scientific Corporation does not assume or authorize any party to assume for it any other obligation or liability.

---

## Satisfaction Guarantee

Should you experience difficulty with the RoVent®, our Technical Support Group will assist you in trouble-shooting and determining if the product needs to be returned to our facility. We will issue you a Return Manufacturer Authorization (RMA) number before the product is shipped back for repair. It is at the discretion of the manufacturer to replace or repair a defective part or product. Please call Customer Service at 888-572-8887 to obtain a Return Manufacturer Authorization number. Shipments without a RMA number will not be accepted. Please note that after our 30-day return policy period ends, we will be happy to assist you with your application, but cannot issue any credit or refund for a returned RoVent®.

Prior to shipment, please clean and decontaminate the product of any chemical, biological, or isotopic contamination. Please include a completed Product Return Form with the shipment. The form can be found on page 68 of this Owner's Manual. This form can be obtained by contacting Kent Scientific Customer Service at 888-572-8887 or 860-626-1172.

## Specifications

---

### *Controller*

Voltage	12 V, 2.5A
Dimensions	13.3cm (5.25in) x 19.1cm (7.50in) x 13.9cm (5.50in)
Weight	1.0kg

### *Power Supply*

Input	100 to 240 V, 50 to 60 Hz, 1.0 A
Output	12 V, 2.5 A

---

## RoVent

Control Modes	Volume controlled, pressure controlled
Respiratory Rate Range	20bpm to 400bpm
Tidal Volume Range	0.01 - 12.0mL
Weight Range	3g to 1,250g

## RightTemp Sensors

Resistance	2,252 Ohm
Operating temperature	-60°C to 150°C (-76°F to 302°F)
Sensor tip diameters	Mouse 0.080" and Rat 0.140"
Time constant in air	15.0sec
Dissipation constant	0.75 m/W (°C)
Conditions	Operating: 0°C to 45°C, 10% to 90% RH, non-condensing Storage: -40°C to 70°C, <90% RH, non-condensing

RoVent and RightTemp are registered trademarks of Kent Scientific Corporation.

# Index

air flow .....	10, 13
alarms .....	2-4
animal sensor .....	14-16
assist mode .....	9
axis .....	3
baffle leaks .....	13
body temperature .....	14
body temp regulated .....	15, 16
body weight .....	2, 4, 8, 10-12
breath cycle .....	8, 9, 12
bypass .....	5, 6
calib & tests .....	7, 12, 13
calibration .....	7, 12, 15, 16
canister .....	6
chart .....	2, 3
compressed gas 5.....	6
config .....	3, 4
data .....	2
deadspace .....	7, 10, 12
default .....	8
enable .....	16
exhaust .....	1, 6, 12
exhaust port .....	6
inlet .....	1, 6
inspiration .....	8
leak test .....	12, 13
low baffle pressure .....	13
maintenance .....	16, 17
maximum pad temp .....	16
maximum pad temperature ...	15
measure deadspace .....	7
more ventilator .....	2, 7, 10, 13
off .....	15
overheating .....	16
pad power .....	14
pad sensor .....	14, 15
pad sensors .....	16
pad temp .....	15, 16
pad temperature .....	15
param .....	2, 3
parameters .....	3, 4, 11
param locations .....	3
party .....	17
PEEP .....	8
port .....	6, 12, 14
positive end-expiratory .....	8
pressure .....	2, 6-13, 19
probe .....	14, 15
pulse mode .....	9
range .....	2, 3, 8, 19
rectum .....	15
remote cable .....	10
respiration rate .....	9, 10
respiration rate .....	2, 9
RightTemp .....	15, 16, 19
scavenging .....	6
set ranges .....	3
set target pressure .....	2, 8
set target volume .....	8
settings .....	2, 7-10, 15, 16
sigh breath .....	8
Specifications .....	18
target pressure .....	2, 8-10
target temperatures .....	16
temperature sensor .....	14, 19
tidal volume .....	8-10, 12, 19
tidal volume .....	7, 12
timing .....	3
trigger .....	10
triggered alarm .....	4
triggers menu .....	10
tubing configuration .....	7
TV .....	12
unregulated .....	15
vaporizer .....	5, 6
ventilator .....	2, 5-13
view .....	2
volume priority .....	8
warming .....	14-16
warming pad .....	14-16
warranty.....	17
zero sensors .....	7



1116 Litchfield Street  
Torrington, Connecticut 06790  
Local: 860-626-1172 Toll-Free: 888-572-8887  
Part No. 10-6000-29